

INVESTIGATION OF THE ELASTIC SCATTERING OF π^- MESONS WITH MOMENTA
6.8 Bev/c FROM PROTONS IN A PROPANE BUBBLE CHAMBER

WANG KANG-CH'ANG, WANG TS' U-CHIENG, TING TA-TS' AO, V. G. IVANOV, Yu. V. KATYSHEV, E. N. KLADNITSKAYA, L. A. KULYUKINA, NGUYEN DINH TY, A. V. NIKITIN, S. Z. OTVINOV-SKIĬ, M. I. SOLOV'EV, R. SOSNOVSKIĬ, and M. D. SHAFRANOV

Joint Institute for Nuclear Research

Submitted to JETP editor August 28, 1959

J. Exptl. Theoret. Phys. (U.S.S.R.) **38**, 426-431 (February, 1960)

The elastic scattering of 6.8 Bev/c negative pions from protons in a propane bubble chamber was studied. The total and differential cross sections for elastic scattering were obtained on the basis of 213 interaction events, and the total cross section for the π^- -p interaction was also estimated:

$$\sigma_{el} (> 6^\circ) = 3.75 \begin{matrix} +0.25 \\ -0.55 \end{matrix} \text{ mb}, \quad \sigma_{tot} = 30 \pm 5 \text{ mb}.$$

It was found that the elastic scattering agreed, within the limits of experimental error, with the model of a proton as a homogeneous sphere with sharp boundaries: $R = 1.05 \times 10^{-13}$ cm, $K = 0.71 \times 10^{13}$ cm $^{-1}$, $k_1 = 0$.

PION-PROTON scattering at high energies, where the de Broglie wavelength is much smaller than the effective region of the interaction, can give useful information on proton structure. In the present work, the investigation of the elastic scattering from protons of negative pions with momenta 6.8 Bev/c (wavelength $\lambda = 0.112 \times 10^{-13}$ cm) was done with a 24-liter propane bubble chamber¹ placed in a magnetic field of 13,700 oe.

Figure 1 shows the placement of the chamber and the other equipment in the pion beam.² The momentum distribution of the pions was obtained along 112 beam tracks measured in the chamber; it is given in Fig. 2. The average value of the momentum was (6.8 ± 0.6) Bev/c.

RESULTS AND ANALYSIS OF THE MEASUREMENTS

Two different scannings of the photographs obtained were carried out with a stereo lens by two persons. In all, about 3500 exposures were examined. From all the two-pronged stars, 550 cases which suggested elastic and quasi-elastic scattering were picked out. The coordinates of the interaction points and of the tracks were calculated with measuring microscopes on both stereo exposures.

The results of the measurements were analyzed by an electronic computer which gave the spatial coordinates of the tracks, the magnitude of the range of the recoil proton (for stoppings), the

pion scattering angle θ_π , the recoil proton angle θ_p , and the azimuthal angles of the pion and of the recoil proton φ_π and φ_p . The error in the angles θ_π and θ_p was determined on the basis of two independent measurements of 80 events. The mean-square errors $\Delta\theta_\pi$ and $\Delta\theta_p$ were found to be 26' and 1° 14' respectively. A correction was introduced for track curvature, although this did not exceed 20'.

The elastic pion-nucleon scattering cases were identified by the following criteria.

1. Coplanarity. As a measure of coplanarity we selected the angle between the plane formed by the incident and scattered pions and the plane formed by the incident pion and the recoil proton. This angle is equal to the modulus of the difference of the azimuthal angles: $\Delta\varphi = |\varphi_p - \varphi_\pi|$. Those events in which $\Delta\varphi$ did not exceed twice the mean square error were taken to be coplanar. The distribution of all 550 events by coplanarity parameter is given in Fig. 3.

2. Angular correlation. A region determined by the mean-square error was laid out along the correlation curve $\theta_\pi = f(\theta_p)$ for 6.8 Bev/c momentum pions. Elastic scattering cases had to lie in this region. Figure 4 shows the distribution of all the cases as a function of deviation from the correlation curve. The doubled mean-square error $\Delta\theta$ is taken as a measure of the deviation.

3. Range of the Recoil Proton (For Stoppings). This criterion was used in about 30% of the cases.

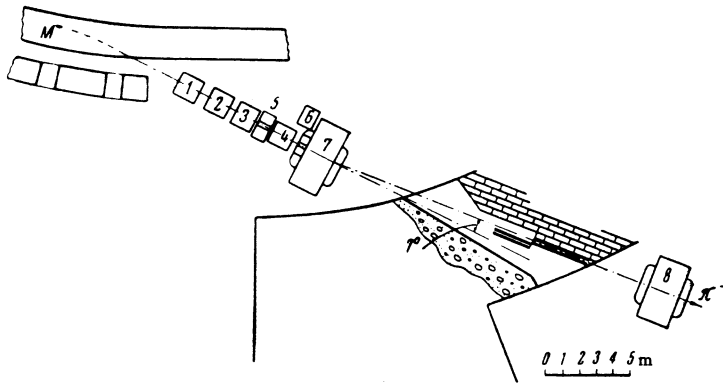

FIG. 1. Setup of equipment in π^- beam. 1-4) fixed focus lenses; 5 and 6) shielding; 7) deflecting magnet; 8) magnet containing chamber; M) beryllium target in accelerator chamber.

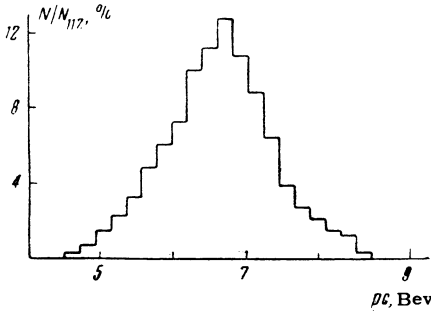

FIG. 2. Relative π^- spectrum obtained from measurements of the moments of 112 beam tracks in the chamber.

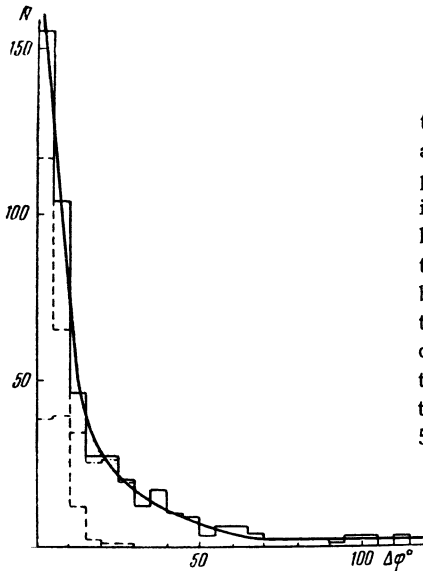

FIG. 3. Distribution of the number of analyzed events by parameter of coplanarity $\Delta\phi$. The dotted histogram refers to the events identified by all criteria as elastic scattering; the dot-dashed one to inelastic scattering events; the solid one to all 550 events.

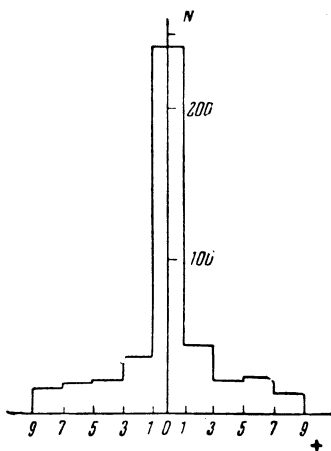

FIG. 4. Distribution of the number of two-pronged stars by deviation from the angular correlation curve. One division of the abscissa corresponds to the doubled mean square error.

Of all of the 550 events measured and analyzed, 218 events were classified as elastic. The distribution of these 218 cases of pion-proton elastic scattering are given in Fig. 5 as a function of longitudinal position in the chamber. A length of 43 cm of the central part of the chamber was taken as the effective region (the overall length of the chamber was 55 cm). Of the 218 events, 213 occurred in the effective region. The distribution of these 213 events by azimuthal angle of the recoil proton is given in Fig. 6.

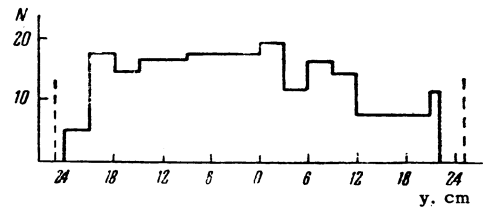

FIG. 5. Distribution of 218 events of elastic π^- -p scattering by length in the chamber. Zero corresponds to the center of the chamber.

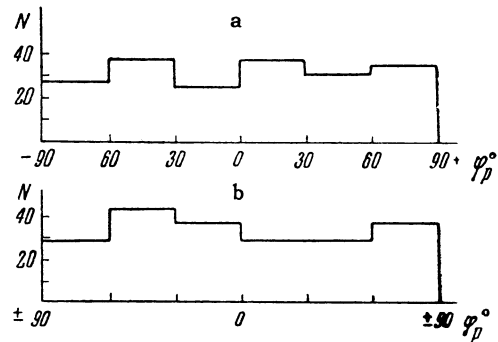

FIG. 6. Distribution of 213 events of elastic π^- -p scattering, selected for analysis by azimuthal angle of the recoil proton φ_p : a) distribution above and below, b) left and right.

In 113 events the recoil proton went upwards, in 100 events downwards, in 115 events to the left, and in 98 cases to the right. Since the distribution by recoil proton azimuthal angle was isotropic, corrections for loss in the region near $\varphi_p = \pm 90^\circ$ were not made.

An estimate of the contribution from quasi-

elastic events to the total number of elastic scattering events was made from the distribution of all events as a function of their deviation from the correlation curve. This contribution was about 6%.

To get the value of the elastic interaction cross sections, we counted, twice for each emulsion, the number of beam π^- tracks going through the effective region of the chamber, and the number of stars induced by beam negative pions. Taking into account the admixture of negative muons, estimated to be $(5 \pm 2)\%$, it was found that total length of tracks of negative pions was 1.15×10^6 cm. In 201 events it was found that

$$\sigma_{e1}(\theta'_\pi > 6^\circ) = 3.75 \begin{matrix} +0.25 \\ -0.55 \end{matrix} \text{ mb},$$

where θ'_π is the pion scattering angle in the center-of-mass system.

An estimate of the total π^- -p interaction cross section was also made. For this, we counted the number of stars containing an even number of prongs, and from them N_1 which had no more than one black track and N_2 which had an odd number of relativistic prongs and no black track. Under the supposition that at this energy $\sigma_t(\pi^- + p) = \sigma_t(\pi^- + n)$, we find that the number of stars created by negative pions from free protons is equal to $N_1 - N_2$. The value of $N_1 - N_2$ found leads to the cross section $\sigma(\pi^- \pm p) = (30 \pm 5)$ mb.

OPTICAL MODEL CALCULATION

We carried out an analysis of the scattering of negative pions from protons on the basis of the optical model. The homogeneous sphere³ was used for a model of the proton. Under the hypothesis that elastic scattering has a purely diffraction character ($\sigma_{e1} = \sigma_d$), we have the following relations expressing the total cross section of inelastic processes σ_i and the diffraction cross section σ_d by optical model parameters:

$$\sigma_i = \pi R^2 \{1 - [1 - (1 + 2B)e^{-2B}] / 2B^2\} \quad B = KR; \quad (1)$$

$$\sigma_d = \sigma_d(K, k_1 = 0) \{1 + 4(k_1/K)^2 [1 - \frac{1}{18} B^2 + \dots]\}, \quad (2)$$

$$\sigma_d(K, k_1 = 0) = (\pi R^2 / 4B^2) \{4B^2 - 14 - 2(1 + 2B)e^{-2B} + 16e^{-B}(1 + B)\}; \quad \frac{d\sigma}{d\Omega}(\theta) = |f(\theta)|^2,$$

$$f(\theta) = ik_0 \int_0^R [1 - e^{(-K+2ik_1)s}] J_0(k_0 \rho \sin \theta) \rho d\rho, \quad (3)$$

$$s = \sqrt{R^2 - \rho^2}.$$

Here $f(\theta)$ is the scattering amplitude, θ is the scattering angle, k_0 is the wave number of the incident pion, k_1 is the change in the real part of the wave number, K is the absorption coefficient of the nucleon, and R is the radius of the sphere.

Calculations of the curves $\frac{d\sigma}{d\Omega}(\theta)$ were carried out for various values of σ_d , σ_i , and R . By comparing the calculated values with the experimental angular distributions, it was ascertained that the experimental data could be best described by a proton model with the following parameters:

$$R = 1.05 \cdot 10^{-13} \text{ cm}, \quad K = 0.71 \cdot 10^{13} \text{ cm}^{-1}, k_1 = 0, \\ \sigma_d = 5.5 \text{ mb}, \quad \sigma_i = 21.0 \text{ mb}.$$

Figure 7 shows the differential cross section of π^- -p scattering for (6.8 ± 0.6) Bev/c, and Fig. 8 gives the dependence of $\lambda^2 d\sigma/d\Omega$ on $(\sin \theta'_\pi)/\lambda$ for negative pions with momentum 1.43 Bev/c, $\lambda = 0.272 \times 10^{-13}$ cm (reference 4) and 6.8 Bev/c,

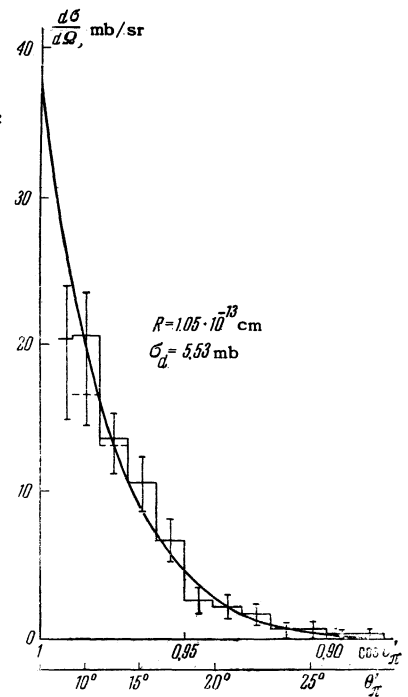

FIG. 7. Differential cross section for elastic π^- -p scattering for average pion momentum (6.8 ± 0.6) Bev/c, based on 213 events. In the angular interval $\cos \theta'_\pi > 0.97$ are added 23 events (shown dotted) which could be identified as elastic scattering by the value of their recoil proton range and whose non-coplanarity did not exceed three times the error. The errors are everywhere statistical.

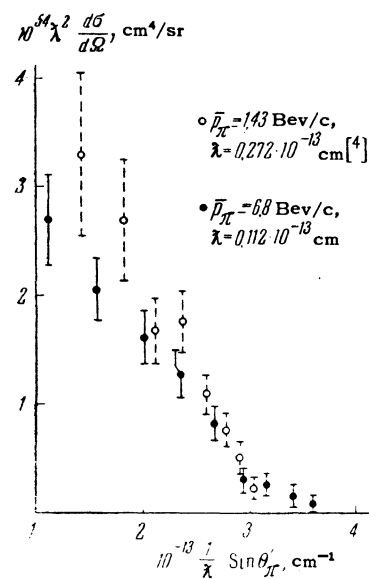

FIG. 8

E, Bev	σ_d , mb	σ_t , mb	$10^{13} R$, cm	$10^{-13} K$, cm ⁻¹	$10^{-13} k_1$, cm ⁻¹	$\sigma_t / \pi R^2$
1.3 [5]	7.4 ± 1.0	26.4 ± 2.2	1.08 ± 0.06	—	—	—
1.4 [6]	7.0 ± 1.0	34 ± 3	1.18 ± 0.10	0.67	~0	0.61 ± 0.10
1.4 [4]	10.1 ± 0.8	30 ± 3	1.08 ± 0.06	—	—	—
4.5 [7]	6.0 ± 1.5	28 ± 2.6	0.90 ± 0.15	—	—	—
5 [8]	4.7 ± 1.0	22.5 ± 2.4	0.90 ± 0.15	1.02	~0	0.6 ± 0.2
6.8	5.5 ± 0.5	30 ± 5 (estimate)	1.05 ± 0.05	0.71	~0	0.61

$\lambda = 0.112 \times 10^{-13}$ cm (present work). From Fig. 8 it follows that, notwithstanding the large energy difference, the connection between the quantities $\lambda^2 d\sigma/d\Omega$ and $(\sin \theta'_\pi)/\lambda$ is expressed by one curve. Evidently the physical significance of this result consists in the constancy of the average value of the transverse momentum transferred in elastic scattering. Consequently, in the energy region considered, the effective collision parameter determining the value of the cross section for the interaction of pions with nucleons does not depend very much on the energy. Therefore R , K , and k_1 do not depend much on the energy. This fact is also attested to by a comparison with other experimental data (see table). The small difference observed in the region of small values of $(\sin \theta'_\pi)/\lambda$ can evidently be explained by the fact that the scattering amplitude at momenta 1.4 Bev/c has a small real part, while at our energies the scattering amplitude is purely imaginary.

In conclusion the authors express their deep gratitude to Academician V. I. Veksler and I. V. Chuvilo for advice, to N. A. Smirnov, E. K. Kuryatnikov, Yu. I. Makarov, and M. A. Samarin for

help with the experiment, and to L. Ya. Ivanova and K. N. Radina for help in carrying out the measurements.

¹ Wang, Solov'ev, and Shkobin, Приборы и техника эксперимента (Instrum. and Meas. Engg.) No. 1, 41 (1959).

² Wang, Ting, Ivanov, Kladnitskaya, Nguyen, Saitov, Solov'ev, and Shafranov, Report, High-Energy Lab. Joint Inst. Nuc. Res., 1959.

³ Fernbach, Serber, and Taylor, Phys. Rev. **75**, 1352 (1948).

⁴ Chretien, Leitner, Samios, Schwartz, and Steinberger, Phys. Rev. **108**, 383 (1957).

⁵ J. Leitner, referred to in reference 7.

⁶ Eisberg, Fowler, Lea, Shephard, Shutt, Thordike, and Whittemore, Phys. Rev. **97**, 797 (1955).

⁷ W. D. Walker, Phys. Rev. **108**, 872 (1957).

⁸ Maenchen, Fowler, Powell, and Wright, Phys. Rev. **108**, 850 (1957).